

Body (24x24cm)

① Colored side down. Collapse to preliminary base.

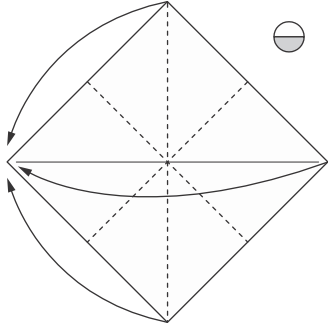

② Four inside reverse folds.

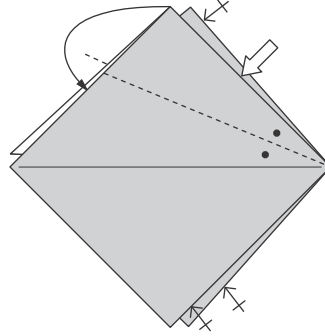

③ Fold down the first upper flap.

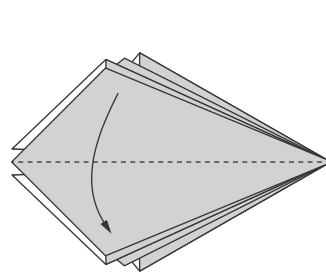

④ Petal fold.

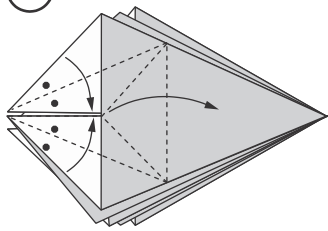

⑤ Fold the little flap to the left.

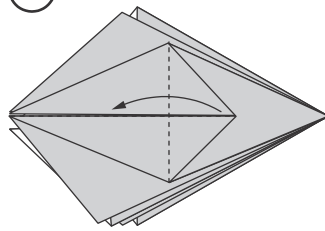

⑥ Extended squash fold.

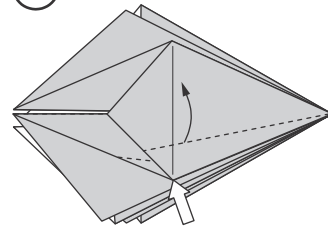

⑦ Rabbit ear with the upper flap. Note the red reference point!

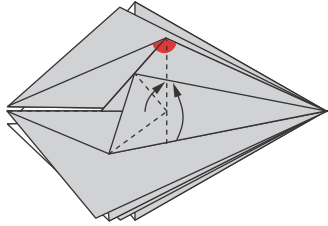

⑧ Fold one flap upward.

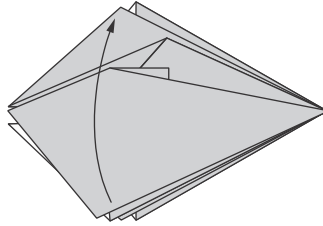

⑨ Petal fold.

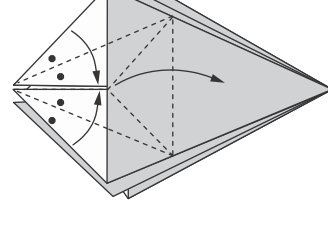

⑩ Fold the little flap to the left.

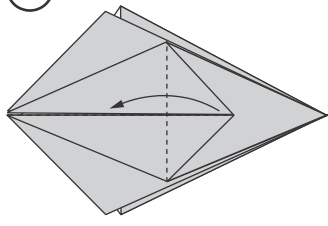

⑪ Extended squash fold.

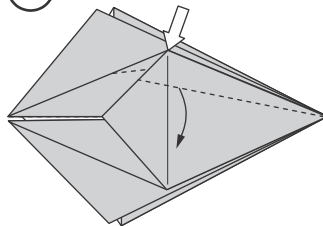

⑫ Rabbit ear with the upper flap. Note the red reference point!

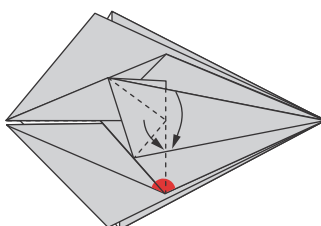

⑬ Turn around.

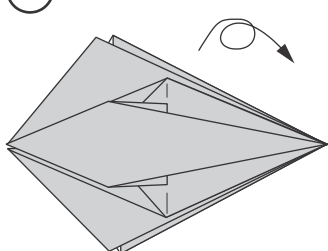

⑭ Repeat steps 3-12.

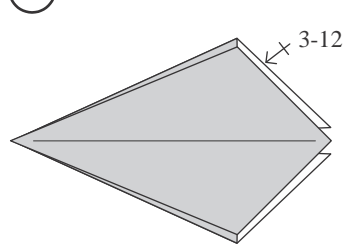

⑮ Fold one flap down.

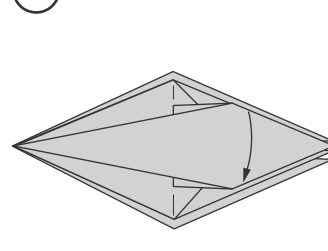

16 Open sink on two flaps.

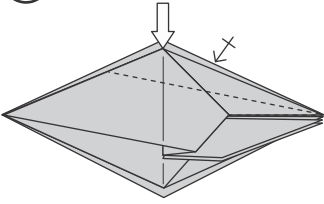

17 Fold one flap upward.

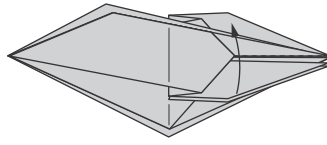

18 Fold one flap upward.

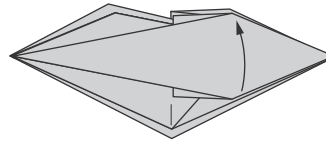

19 Open sink on two flaps.

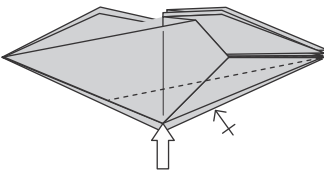

20 Fold one flap upward.

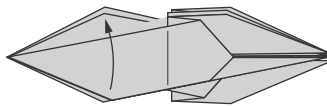

21 Turn around.

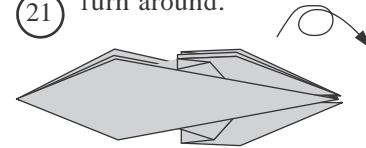

22 Fold one flap down.

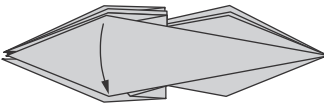

23 Fold one flap down.

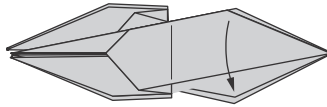

24 Open sink fold.

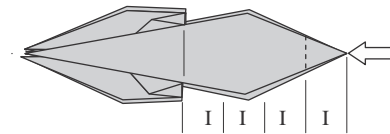

25 Fold the left upper tip to the right. Repeat behind.

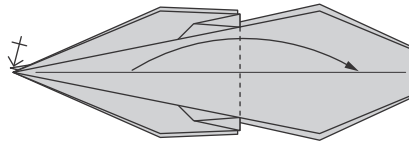

26 Fold and unfold. Repeat behind.

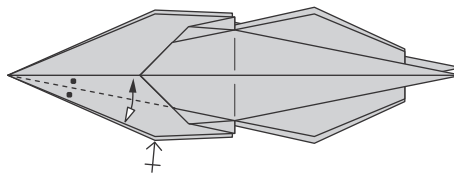

27 Swivel fold the striped upper layer. After this edge B shall lie in parallel to edge C. Swivel fold the striped lower layer with corner A to the crease D made in step 26. Repeat behind.

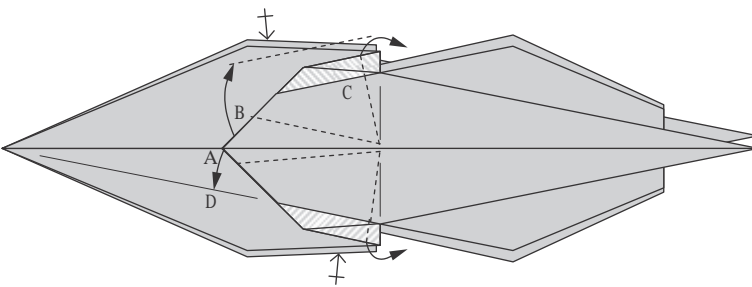

28 Fold in half both left tips. Simultaneously make on the right of the tips two little swivel folds. Repeat behind.

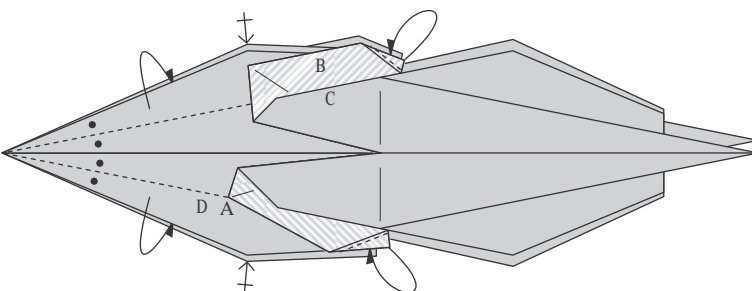

29

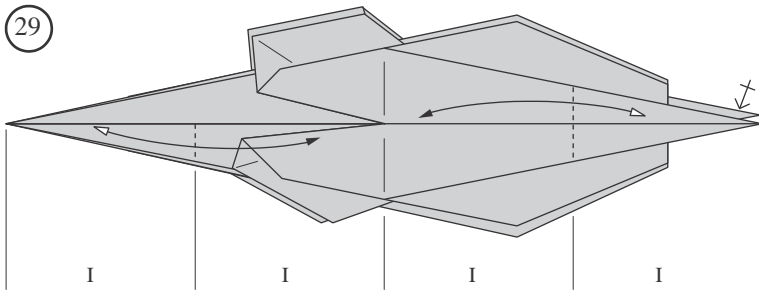

Precrease three times.

30

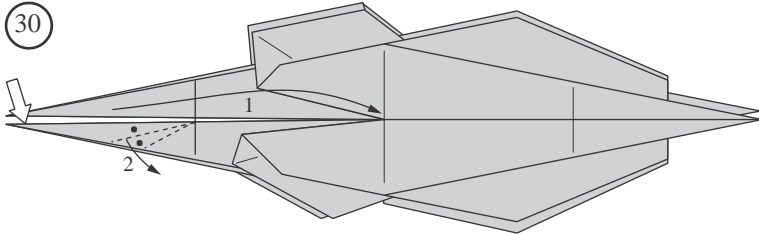

1: Fold the left upper tip to the right.  
(This unneeded tip shell be the subject of concern for a creative task later.)

2: Squash fold the left lower tip.

31

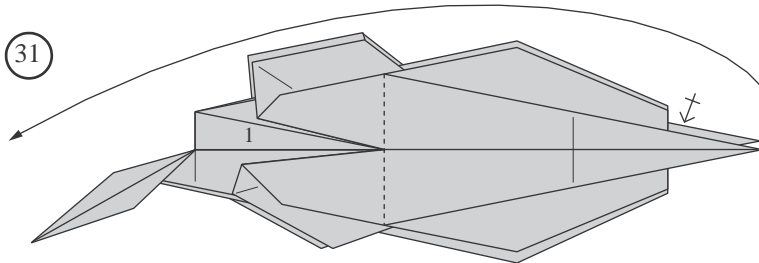

Fold both right tips to the left.

32

Pleat fold. Repeat behind.

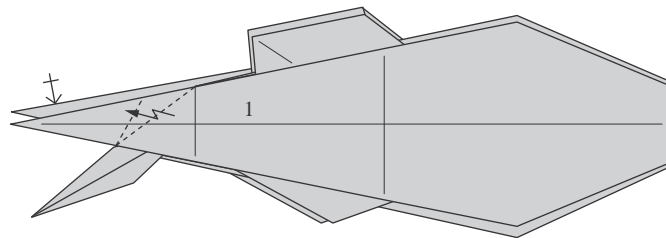

33

Finished body.

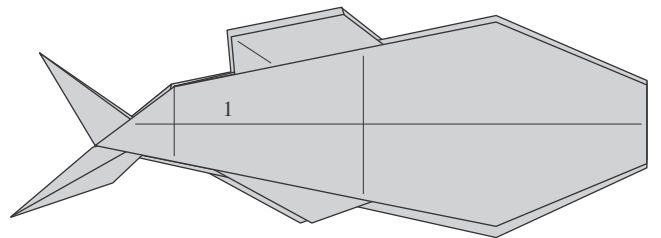

Head 10x10 cm

34

Collapse to waterbomb base.

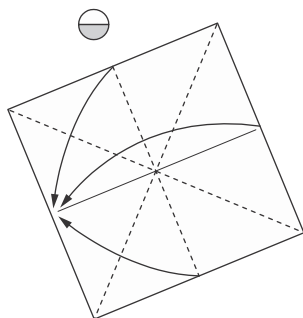

35

Fold and unfold. Repeat behind.

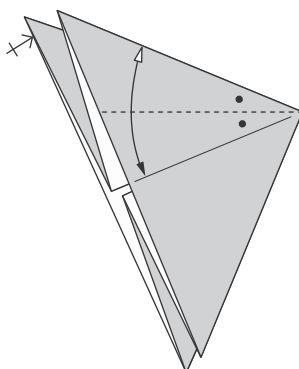

36

Inside reverse fold in using the existing creases.

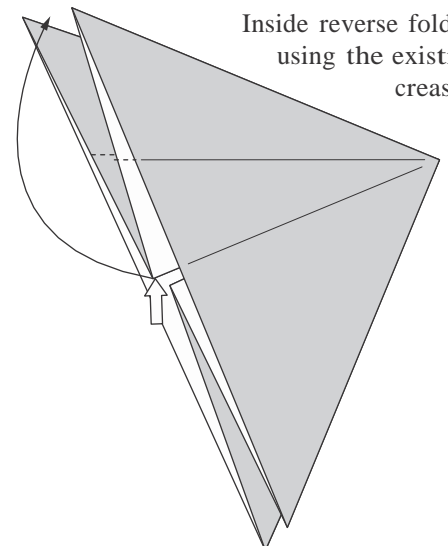

37 Squash fold.  
Repeat behind.

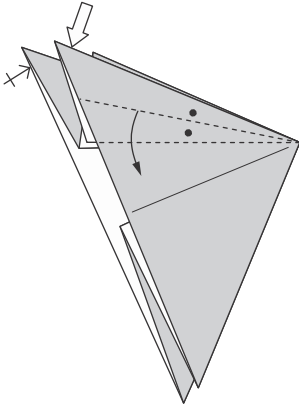

38 Petal fold.  
Repeat behind.

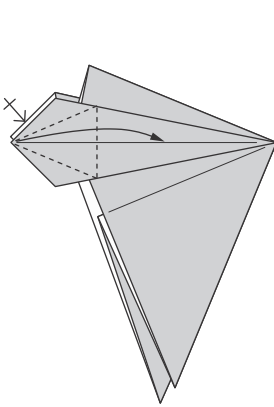

39 Fold up the little flap.  
Repeat behind.

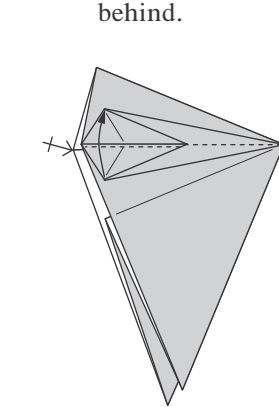

40 Fold up the big flap.  
Repeat behind.

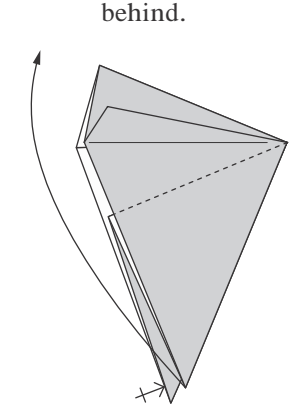

41 Rabbit ear.  
Repeat behind.

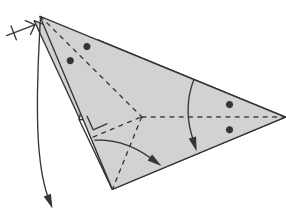

42 Fold and unfold  
two times.  
Repeat behind.

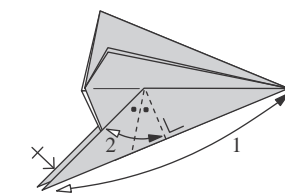

43 Squash fold.  
Repeat behind.

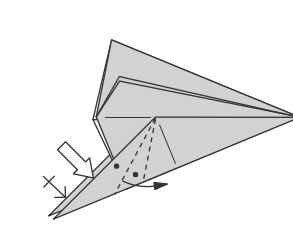

44 Fold down one  
little flap.  
Repeat behind.

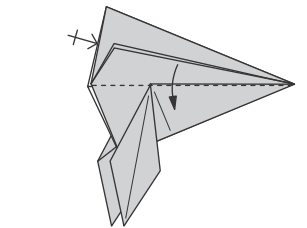

45 1: Inside reverse fold.  
2: Closed sink.

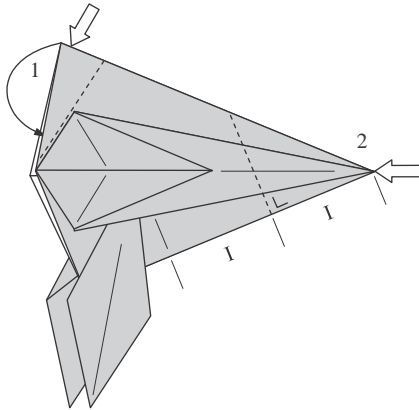

46 Fold and unfold.  
Repeat behind.

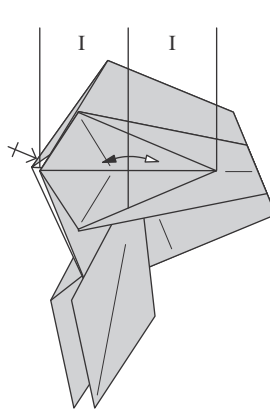

47 Fold and unfold.  
Repeat behind.

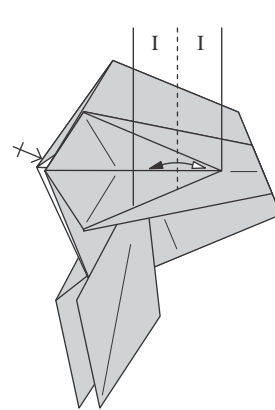

48 Squash fold.  
Repeat behind.

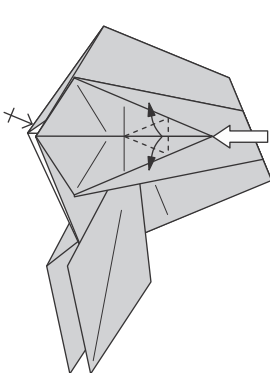

49 Valley fold.  
Repeat behind.

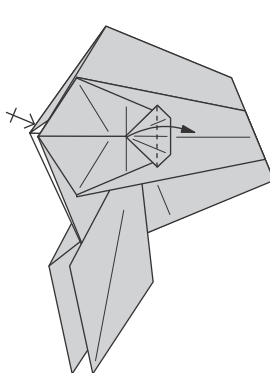

50 Finished head.

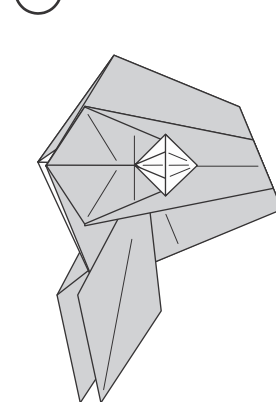

Wing 15x15 cm

51 Fold and unfold. Then turn over the model.

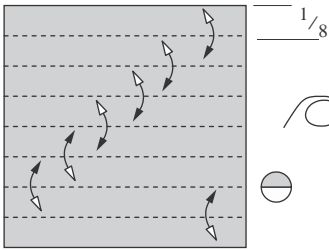

52 Fold and unfold.

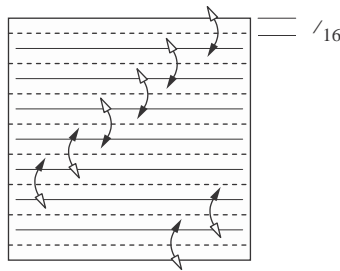

53 Fold and unfold.

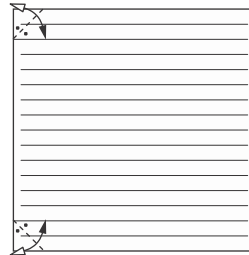

54 Fold and unfold.

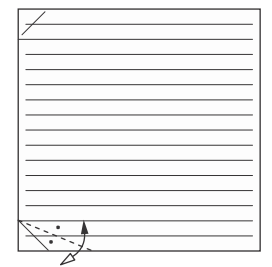

55 Two valley folds.

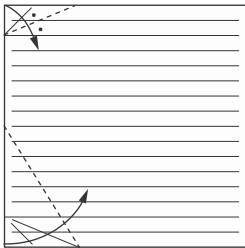

56 Multiple pleat fold.

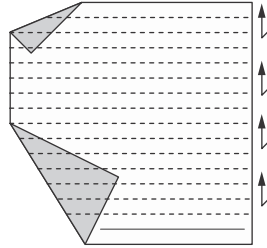

57 Valley fold.

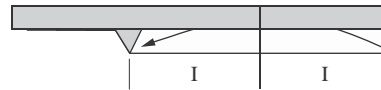

58 Tuck the flap into the nearest pocket.

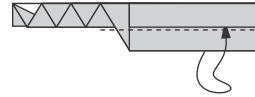

59 Open the wing as shown in the next step.

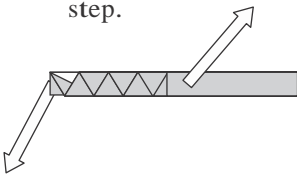

60 Finished wing.

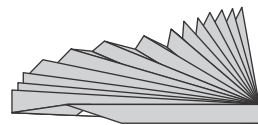

Assemble the flying fish

Tuck the front of the body into the head (glue). Glue the wing behind the head left and right.

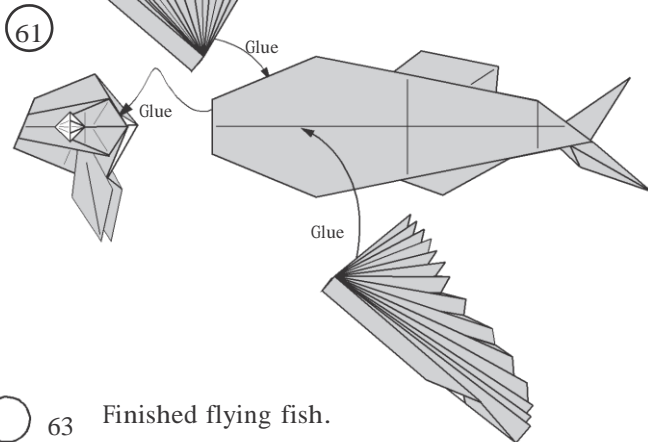

62 Fold to the inner. Repeat behind.

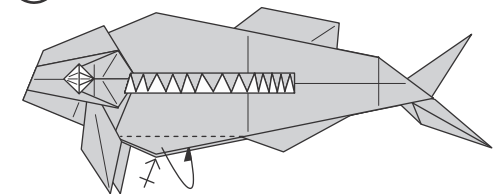

63 Finished flying fish.

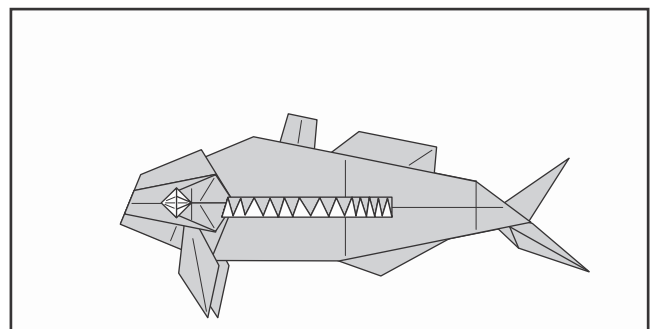
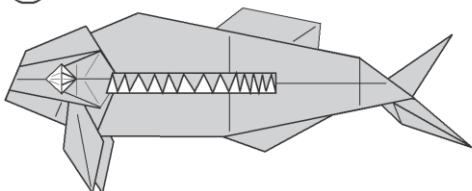

Creative task: Fold an additional dorsal fin. Use the unneeded tip you fold to the interior in step 30.

<http://www.freewebs.com/falkunst/downloads/flyingfish.v03.pdf>

